

AMBIANCE BAIN CRÉE \*  
L'EXALTITUDE



Ab  
ambiance bain

AMBIANCE BAIN CRÉE \*  
L'EXALTITUDE

[www.ambiancebain.com](http://www.ambiancebain.com)

\* Attitude d'exaltation permanente / A permanent attitude of exaltation

# SOM MAIRE

# CON TENT

WATERCONCEPT	4
ABACA	66
CAPIA	30
CITY	24
DELTA	76
DOLCE	18
EASYLIFE	64
EDEN	54
KITOÏ	46
MAMBO	75
MYSTA	34
OMEGA	68
PLAZZA	12
QUADRA	40
TAKOMA	36
TEMPO	58
YOKO	72
ZETA	70
GUIDE TECHNIQUE	77



FABRICATION  
FRANÇAISE



PLAN-VASQUE  
BÉTON SMO™



MEUBLE  
LIVRÉ MONTÉ



GARANTIE  
5 ANS\*



INSTALLATION  
FACILE



SOLUTIONS  
SUR-MESURE

\* Voir conditions générales de vente / Please refer to our terms and conditions

# UN FABRICANT FRANÇAIS QUI ASSOCIE HISTOIRE, SAVOIR-FAIRE ET DESIGN PRODUIT

## UN FABRICANT FRANÇAIS

Au départ une petite unité de fabrication familiale de la Vallée du Rhône, qui peu à peu exploite son succès pour avancer et se développer tout en étoffant son savoir-faire et sa technologie. Une entreprise qui aujourd'hui s'appuie sur la 3<sup>ème</sup> génération de la famille et sur des équipes passionnées, servies par des outils de pointe. Une marque qui rayonne dans de nombreux pays en Europe.

## LA PASSION DE LA CRÉATION : FORME ET FONCTION

Notre force, nous la puisons dans nos échanges avec tous nos collaborateurs, partenaires, designers, créatifs ou techniciens pour créer, innover, expérimenter de nouvelles pistes, de nouveaux design. Chaque meuble est pensé en premier lieu pour sa fonction dans la salle de bains, par qui et comment va-t-il être utilisé, puis pour sa forme (design, matériau, couleurs...) et enfin pour ses équipements, sa technologie (ouverture électrique, tiroirs aménagés...). Un concentré de design, d'ergonomie et d'une touche de fantaisie, signature de la marque et de son savoir-faire.

## UN CONCEPT INNOVANT

Depuis de nombreuses années, nous proposons à nos clients d'harmoniser leur salle de bains en couleur et en matériau grâce à notre Béton de Synthèse antibactérien exclusif, commercialisé sous la marque SMO™. Un matériau idéal pour les plans vasques, les receveurs et les panneaux de douche sur-mesure, une innovation fédérée autour d'une appellation : **LE WATERCONCEPT.**

## DU MOBILIER DE QUALITÉ

Tous les meubles Ambiance Bain sont livrés montés et équipés des dernières générations de coulisses et charnières avec amortisseurs intégrés. Les chants sont appliqués au laser pour une qualité de finition irréprochable. Les matières premières de haute qualité sont sélectionnées auprès des plus grands fabricants européens et font l'objet d'un contrôle rigoureux. Les plans de toilette et les douches SMO™ sont fabriqués individuellement et bénéficient d'un soin particulier dans toutes les phases d'une production dans les règles de l'art.

## L'ENGAGEMENT DURABLE

Ambiance Bain s'engage au quotidien pour réduire sa consommation d'énergie, recycler ses déchets de production, rationaliser ses découpes, ses chutes et apporter une pierre à l'effort commun de respect de l'environnement. Nous nous attachons particulièrement à la sélection de nos matières premières et de nos partenaires dans le respect des normes environnementales en vigueur. Nos produits de qualité s'inscrivent avant tout dans la durée, évitant ainsi des remplacements prématurés et des déchets qui s'accumulent.





# A FRENCH MANUFACTURER WHICH COMBINES HISTORY, KNOWLEDGE AND PRODUCT DESIGN

## A FRENCH MANUFACTURER

Originally a small family manufacturing unit in the Rhone Valley, who gradually exploited its success to progress and grow, while at the same time developing its skills and technology. The business now relies on the third generation of the family and its enthusiastic teams using cutting-edge machinery and practices. The brand is now popular in many European countries.

## ENTHUSIASM FOR CREATION : FORM AND FUNCTION

Our strength is drawn from communication with all of our employees, partners, designers, creators and technicians which provide us with the impetus to create, innovate and pursue new avenues and designs. Each piece of furniture is designed firstly for its function in the bathroom, by whom and how it will be used, then for its form (design, material, colour, etc.) and finally for its components and technology (electrical opening, fitted drawers, etc.). A collection designed to integrate with the flow of modern times, focusing on design, ergonomics with a touch of fantasy, signature of the brand and its skill and expertise

## AN INNOVATIVE CONCEPT

For a number of years we have proposed an exclusive solution to create bathrooms in a single material and colour using our antibacterial synthetic resin under the brand SMO™. An ideal moulded material for worktops, basins, bath decks, shower trays and wall panels, an innovative solution with a single name: **WATERCONCEPT**.

## QUALITY FURNITURE

All Ambiance Bain furniture is delivered assembled and fitted with the latest generation of runners and hinges incorporating built-in soft close features. The edges are applied using laser technology to ensure an impeccable quality finish. The high-quality raw materials are selected from the ranges of the very best European manufacturers and are subject to strict controls. The SMO™ Synthetic Resin worktops and showers are individually manufactured and benefit from special care during all phases of production in accordance with industrial best practices.

## SUSTAINABLE COMMITMENT

Ambiance Bain undertakes to reduce its daily energy consumption, recycle its production waste, optimize its cutting plans and offcuts and contribute to the common goal of respecting the environment. We are particularly committed to selecting our raw materials and partners to ensure compliance with the applicable environmental standards. But above all, our quality products are made to last, thus avoiding premature replacement and the accumulation of waste.



# WATERCONCEPT

UNE EXCLUSIVITÉ AMBIANCE BAIN

## LE BÉTON DE SYNTHÈSE SMO™

Le Béton de Synthèse SMO™ est un matériau exclusif, conçu et fabriqué par Ambiance Bain. Il est constitué d'un mélange de pierre naturelle, de résine polyester et d'un gelcoat de surface antibactérien. Il répond non seulement à toutes les contraintes sanitaires de la salle de bains et permet également de réaliser tous types de formes suivant une large palette de coloris.

## MÊME MATÉRIAU MÊME COULEUR MÊME FINITION

Le **Waterconcept** est l'ensemble des éléments sanitaires ou décoratifs SMO™ d'une salle de bains Ambiance Bain : **plan de toilette, vasque, receveur, panneaux de douche et tablettes...**

## SMO™ SYNTHETIC RESIN

*SMO™ Synthetic Resin is an exclusive material made from a mixture of natural stone, polyester resin and an antibacterial surface gel coat. Not only does it meet all the sanitary constraints in the bathroom, it also enables us to make all types of shapes in a large colour range.*

## SAME MATERIAL SAME COLOUR SAME FINISH

*Waterconcept is a suite of Ambiance Bain bathroom sanitary or decorative elements made from SMO™ Synthetic Resin: **Worktop, basin, shower-tray, wall cladding and shelves...***

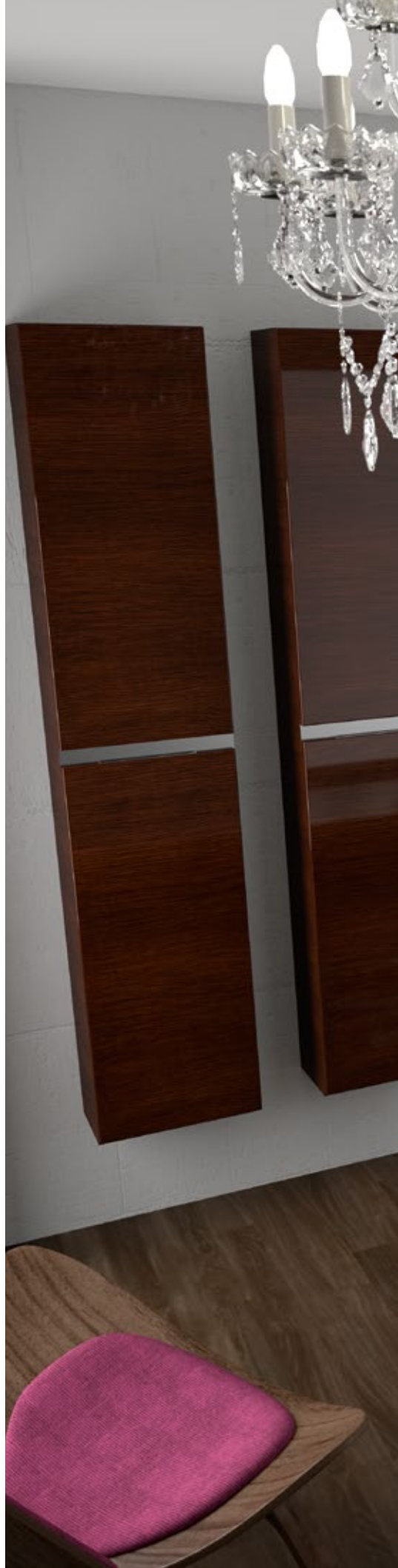





## UNE SOLUTION ESTHÉTIQUE

- Harmonisez votre meuble et votre douche
- Aucun joint
- Un matériau contemporain au toucher doux et minéral
- Un large éventail de coloris de plan de toilette et de douche

## UNE SOLUTION PRATIQUE & TECHNIQUE POUR L'AGENCEMENT ET LA RÉNOVATION

- Dimension sur-mesure
- Solutions d'agencement pour les petites salles de bains
- Solutions pour les contraintes d'accessibilité pour tous

## UNE MISE EN OEUVRE SIMPLIFIÉE

- Pose sur revêtement existant
- Facile à découper et à ajuster sur place
- Pas de réagréage
- Gain de temps pour la mise en oeuvre

## UNE SOLUTION HYGIÉNIQUE

- Facile à nettoyer, sans aucun joint
- Traité antibactérien dans tous les coloris
- Résistant aux produits de nettoyage quotidien



## AN AESTHETIC SOLUTION

- Harmonise your furniture and your shower
- No visible silicon seals
- A contemporary material, both soft to the touch and warm
- The widest possible range of colors for the worktop, basin and shower

## A PRACTICAL AND TECHNICAL SOLUTION FOR INSTALLATION AND RENOVATION

- Made-to-measure dimensions
- Installation solutions for small bathrooms
- Solutions for all types of accessibility constraint

## SIMPLIFIED INSTALLATION

- Installation over existing wall/floor coverings
- Easy to cut and adjust on-site
- No screeding necessary
- Time-saving during installation

## A HYGIENIC SOLUTION

- Easy to clean without any joints
- Antibacterial treatment in all colors
- Resistant to normal cleaning products



# WATERCONCEPT

UNE EXCLUSIVITÉ AMBIANCE BAIN

## UN MATÉRIAU UNIQUE POUR TOUTE LA SALLE DE BAINS

Choisissez une seule couleur pour votre plan de toilette, votre receveur et vos panneaux de douche. Une offre unique qui se décline sur toute la collection Ambiance Bain. Un matériau au toucher minéral qui remplace la plupart des revêtements habituels. Fini les aspérités, le nettoyage des surfaces est extrêmement aisé. Hygiénique, SMO™ est traité antibactérien dans tous les coloris de la gamme. Testé et contrôlé par notre bureau d'étude, il est résistant aux chocs thermiques et aux produits de nettoyage du quotidien.

## UN MATÉRIAU IDÉAL POUR LES DOUCHES SUR-MESURE

Dans le cas d'une rénovation complète de salle de bains, SMO™ offre une grande souplesse d'adaptation aux contraintes de l'environnement rencontré. Les gaines techniques et les angles sont extrêmement faciles à habiller. La pose sans réagréage, ni préparation préalable, simplifie des travaux souvent contraignants tout en économisant sur le temps de séchage et de mise en oeuvre. Les découpes d'angles sont réalisables directement sur place car le SMO™ se découpe et se perce facilement. Pas de joints de carrelage à réaliser ni à entretenir.

## A UNIQUE MATERIAL FOR EVERYTHING IN THE BATHROOM

Choose a single color for your worktop, basin, shower tray and wall cladding. A unique offer available for most of the Ambiance Bain collections. A material with a mineral feel that can replace most of the usual finishes. Say goodbye to roughness, these surfaces are extremely easy to clean. SMO™ is hygienic. Antibacterial treatment is used for all the colors in the range. Tested and inspected by our design office, it resists thermal shock and daily cleaning products.

## AN IDEAL MATERIAL FOR MADE-TO-MEASURE SHOWERS

For complete renovation of a bathroom, SMO™ offers great flexibility for adapting to the constraints of the environment encountered. It is extremely easy to finish pipe boxing ducts and angles. Installation without screeds or prior preparation simplifies work which can often be difficult, while saving drying time and labour costs. Angle cuts can be performed directly on site, because SMO™ can be easily cut and drilled. No grout joints to be created or cleaned.

Plan de toilette  
Worktop



Tablette de demi-colonne assortie  
Matched midi unit panel

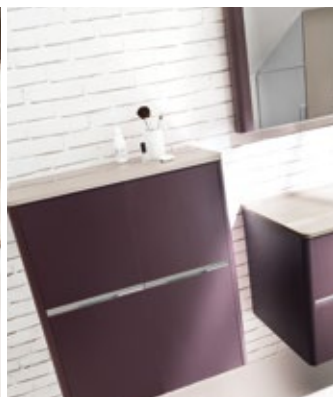

Une douche complète, receveur, panneaux muraux et banc entièrement sur-mesure. A complete made-to-measure shower tray, seat wall cladding and bench.

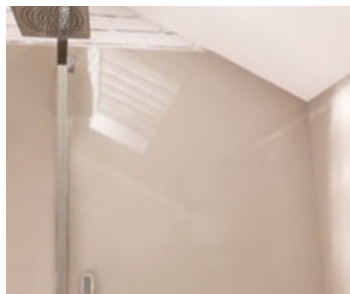

Coupe d'angle facile à réaliser sur place  
Angle cuts are easy to perform on-site

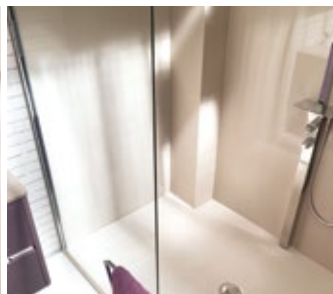

Habillage d'une gaine technique  
Finish of a pipe boxing duct

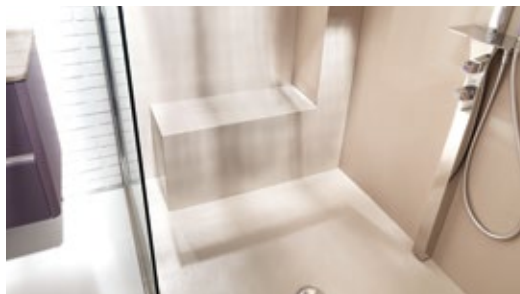

Banc d'assise  
Bench seat

## 4 TYPES DE RECEVEURS DE DOUCHE SUR-MESURE 4 TYPES OF MADE-TO-MEASURE SHOWER TRAY



**ZBSI** : Receveur à l'italienne à **encastrer**  
**ZBSI** : Italian-style **recessed** shower tray

Un receveur élégant, à fleur du sol. La référence des receveurs à l'italienne.  
*An elegant shower tray, flush with the floor. The reference in Italian-style shower trays.*



**ZBSR** : Receveur à l'italienne à **poser**  
**ZBSR** : **Surface-mounted** Italian-style shower tray

Un receveur design pour les salles de bains ne permettant pas d'encastrer une douche.  
*A stylish shower tray for bathrooms where it is not possible or desirable to recess the shower tray.*

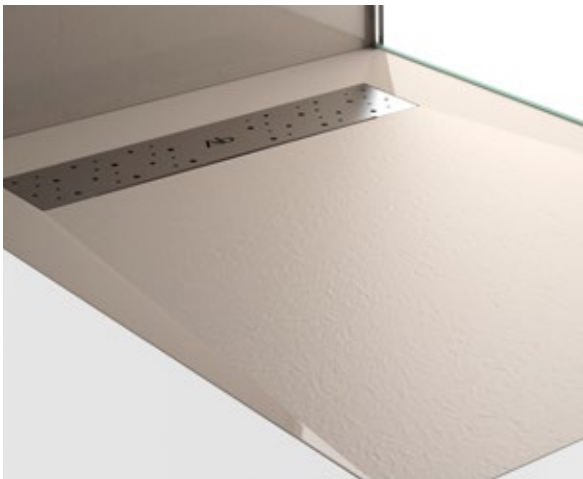

**ZBCAN** : Receveur à écoulement type "caniveau" à **poser ou à encastrer**  
**ZBCAN** : "Channel waste" shower tray for **recessed or surface**

L'écoulement de ce receveur en pente douce se fait au travers d'une grille inox brillant. Revêtement "Stone Feeling".  
*Drainage of this slight slope shower tray is via a thin and shiny stainless-steel grid. "Stone feeling" coating.*



**ZBSTA** : Receveur surface "Stone Feeling" à **poser ou à encastrer**  
**ZBSTA** : Shower tray with "Stone Feeling" coating for **recessed or surface mounting**

Ce receveur aspect pierre naturelle dispose d'un vidage par une grille inox brillant carrée.  
*This shower tray with natural stone appearance have a drainage via a stainless-steel squared grid.*

### CONFORT ET ACCESSIBILITÉ POUR TOUS

- Receveur à l'italienne (ZBSI) conforme aux normes d'accessibilité pour tous.
- Intégralement encastré ou posé avec une hauteur maximum de 2 cm pour ne pas gêner l'accès.
- Surface structurée des receveurs.
- Option antidérapante PN12.
- Banc d'assise sur-mesure, dans le même matériau et la même couleur.
- Dimensions généreuses des grandes douches permettent d'accueillir un accompagnant ou de faire entrer un fauteuil roulant.

### COMFORT AND ACCESSIBILITY FOR EVERYONE

- *ZBSI wetroom style shower tray complies with the standards for accessibility for everyone.*
- *Completely recessed or installed with a maximum height of 2 cm so as not to obstruct access.*
- *Structured surface can be complemented by a anti-slip finish.*
- *Made-to-measure bench seat made from the same material in the same colour.*
- *The generous dimensions of the large showers enable use with carer or in a wheelchair.*



# WATERCONCEPT

UNE EXCLUSIVITÉ AMBIANCE BAIN



## UNE PALETTE DE COLORIS UNIQUE POUR LA SALLE DE BAINS

Longtemps, les plans de toilette et les vasques se sont cantonnés au blanc, synonyme d'hygiène. Aujourd'hui, grâce au Béton de Synthèse SMO™ **antibactérien**, il est possible, au même titre que dans les autres pièces de la maison, de réaliser des associations de couleurs chics, contemporaines ou acidulées, tout en améliorant le niveau d'hygiène et de propreté.

## A UNIQUE RANGE OF COLOURS FOR BATHROOMS

*Worktops and basins were limited to white for a long time, as white meant hygiene. Now, thanks to **antibacterial** SMO™ Synthetic Resin, it is possible, just like in any other room in the house, to combine stylish, contemporary or bright colours, while at the same time increasing levels of hygiene and cleanliness.*



\* Coloris brillant - Gloss colour

# PLAZZA





Concept PLAZ1411MQ, meuble/unit L856, vasque/basin SMO 211, dimensions L/W 140 cm x P/D 50 cm, Miroir/mirror PLAZMI140. Colonne/tall units PLAZAD + PLAZAG. Receveur de douche assorti/matching shower tray ZBSR SMO 211, dimensions L/W 175 cm x P/D 120 cm, panneau de douche/wall cladding ZPAN SMO 211, dimensions L/W 175 cm x H/H 220 cm.



# PLAZZA

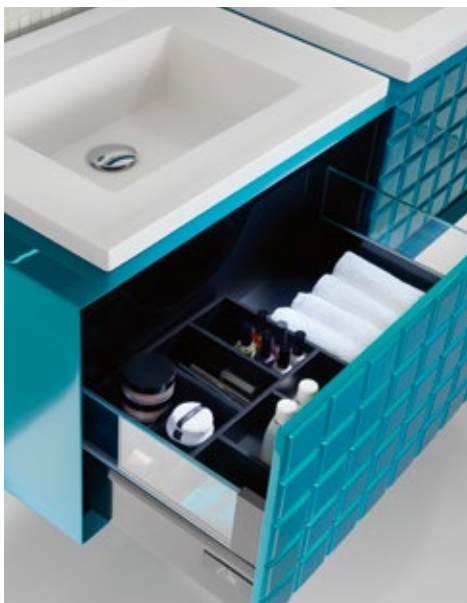

Façade laquée relief, motif quadrillé. *Patterned lacquered front.*





Concept PLAZ1050ML, meuble/unit L850, plan vasque/basin SMO 210, dimensions L/W 105 cm x P/D 50 cm. Miroir/mirror PLAZM1105.  
Banc/bench PLAZBAN L850. Receveur de douche assorti/matching shower tray ZBSR SMO 210, dimensions L/W 90 cm x P/D 120 cm,  
panneau de douche/wall cladding ZPAN SMO 210, dimensions L/W 90 cm x H/H 220 cm.



# PLAZZA



Façade personnalisée selon votre motif.  
Personalised fascia to your own pattern.



Façade lisse. Smooth flat fascia.  
Tiroir à ouverture manuelle ou par assistance électrique.  
Manually opening or electrically assisted.

# DOLCE

Les tiroirs en partie haute du meuble sous-vasque sont équipés d'un range-cosmétiques compartimenté aspect cuir.  
*Top under sink drawers include cosmetics dividers with leather touching aspect.*





Concept DOLCE700, meuble/unit F01, plan vasque/basin SMO 213, dimensions L/W 182 cm x P/D 50 cm. Meuble haut/wall hung unit DOLCC7620 .  
Miroir/mirror DOLCEMI76 x 2 + applique/light ECSAN x 2. Receveur de douche assorti/matching shower tray ZBSI SMO 213, dimensions L/W 120 cm x P/D 200 cm,  
panneaux de douche sur-mesure/made to measure wall cladding ZPAN SMO 213. Banc de douche assorti/matching shower bench ZSIED.





Concept DOLCE60, meuble/unit F71, plan vasque/basin SMO 222, dimensions L/W 147 cm x P/D 50 cm. Demi-colonne/midi unit DOLC7633. Miroir/mirror DOLCEMI46. Receveur de douche assorti/matching shower tray ZBSI SMO 222, dimensions L/W 90 cm x P/D 160 cm, panneaux de douche sur-mesure/made to measure wall cladding ZPAN SMO 222. Banc de douche assortie/matching shower bench ZSIEG.

DOLCE









Concept DOLC700, meuble/unit F46, plan vasque/worktop SMO 268, dimensions L/W 182 cm x P/D 50 cm. Miroir/mirror DOLCMI70 x 2.  
 Colonne/tall unit DOLCAG x 2. Receveur de douche assorti/matching shower tray ZBSR SMO 268, dimensions L/W 200 cm x P/D 120 cm,  
 panneaux de douche/wall cladding ZPAN SMO 268, dimensions L/W 200 cm x H/H 220 cm et/and L/W 120 cm x H/H 220 cm.





Concept CITY41PO, façade/front F01, plan vasque/worktop SMO 240, dimensions L/W 142 cm x P/D 50 cm. Miroir/mirror MINE140. Armoire de rangement LIFT/LIFT unit, dimensions L/W 175 cm x P/D 22 cm. Rangements muraux/wall units MULTI2D + CUBEFD. Receveur de douche assorti/matching shower tray ZBSI SMO 240, dimensions L/W 200 cm x P/D 120 cm, panneaux de douche/wall cladding ZPAN SMO 211, dimensions L/W 120 cm x H/H 220 cm.



Meuble city avec poignées 166/168. 5 modèles de poignées au choix.  
City unit with handles 166/168. Choice of 5 different handles.

# CITY

Ouverture des tiroirs par prise de mains sur profilé chromé brillant.  
*Drawers opening with chromed trim and handgrip.*

Concept CITY29PM, meuble/unit F38, plan vasque/worktop SMO 224, dimensions L/W 126 cm x P/D 50 cm. Miroir/mirror MIDAV120, Colonne/tall unit CITYA3533PM x 2, Receveur de douche assorti/matching shower tray ZBSTA "Stone Feeling" SMO 224, dimensions L/W 90 cm x P/D 120 cm, panneaux de douche/wall cladding ZPAN SMO 224, dimensions L/W 90 cm x H/H 220 cm et/and L/W 119 cm x H/H 220 cm.







# CITY



Concept CITY81PU, meuble/unit F71, plan vasque/worktop SMO 200,  
dimensions L/W 212 cm x P/D 50 cm. Miroir/mirror MIDO140.

Sans poignée, ouverture par système Push-Latch.  
Without handles, opening by Push-Latch system.





# CAPIA



Concept CAPIA156, meuble/unit F01, plan vasque/worktop SMO 214, dimensions L/W 176 cm x P/D 50 cm. Miroir/mirror MINE70 x 2.





# CAPIA

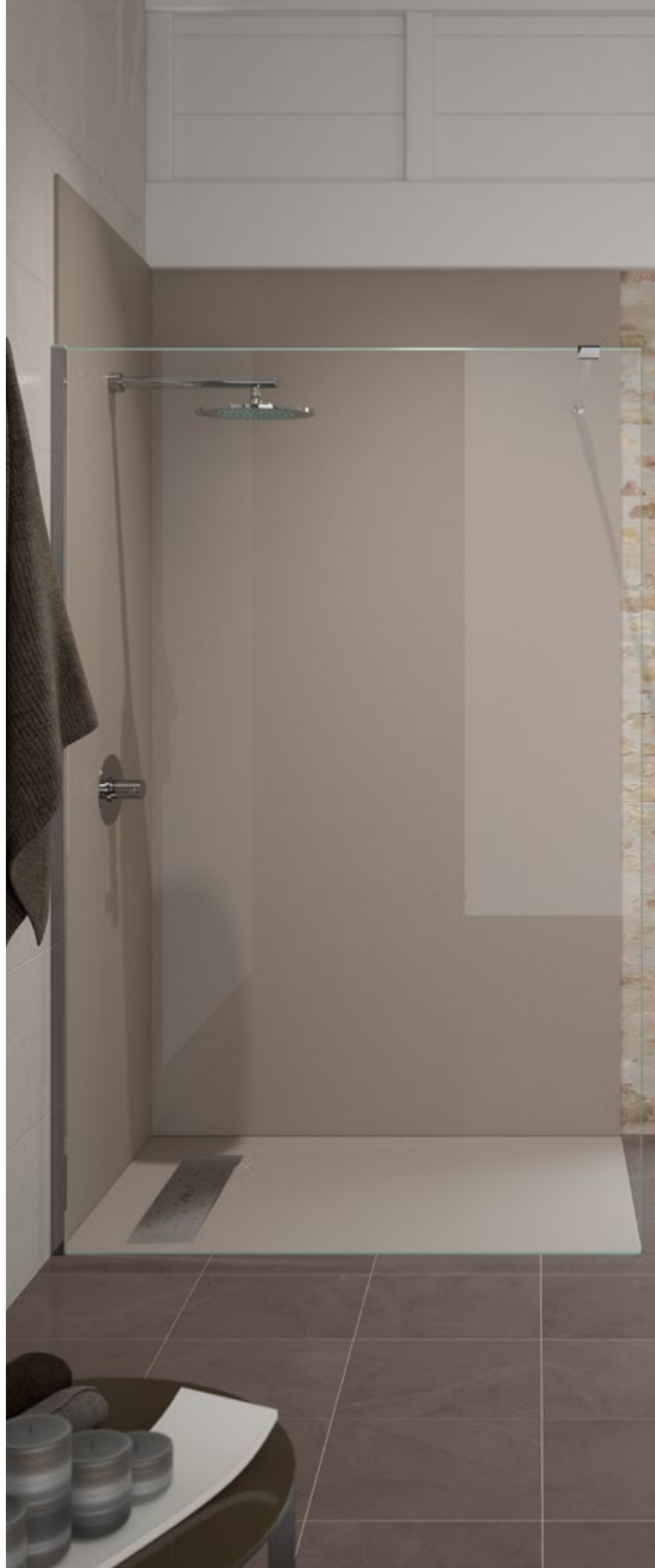

Concept CAPIA51, meuble/unit M741, plan vasque/worktop SMO 222, dimensions L/W 106 cm x P/D 50 cm. Miroir/mirror MIDAV105. Receveur de douche assorti/matching shower tray ZBCAN SMO 222, dimensions L/W 90 cm x P/D 120 cm, panneaux de douche/wall cladding ZPAN SMO 222, dimensions L/W 120 cm x H/H 220 cm et/and L/W 90 cm x H/H 220 cm.





# MYSTA





Concept MYSTA101, meuble/unit F01, plan vasque/worktop SMO 214, dimensions L/W 141 cm x P/D 50 cm.  
Armoire de toilette/mirror cabinet ATNE140, Receveur de douche assorti/matching shower tray ZBCAN SMO 214,  
dimensions L/W 90 cm x P/D 120 cm, panneaux de douche/wall cladding ZPAN SMO 214,  
dimensions L/W 90 cm x H/H 220 cm et/and L/W 120 cm x H/H 220 cm.



# TAKOMA





Concept TAKOMA252 poignée/handle 73, meuble/unit F73, plan vasque/worktop SMO 268, dimensions L/W 216 cm x P/D 46/36 cm.  
Miroir/mirror MIPX. Receveur de douche assorti/matching shower tray ZBSI SMO 268, dimensions L/W 200 cm x P/D 120 cm, panneaux de douche/wall cladding ZPAN SMO 268, dimensions L/W 200 cm x H/H 240 cm.



# TAKOMA





Concept TAKOMA210 poignée/handle 38, meuble/unit F50, plan vasque/worktop SMO RAL7006, dimensions L/W 91 cm x P/D 46/36 cm. Miroir/mirror MILDH90.





Concept: QUADRA41, meuble/unit M741, plan vasque/worktop SMO 200, dimensions L/W 121 cm x P/D 50 cm. Miroir/mirror MILDH120. Armoire de rangement LIFT/LIFT unit, dimensions L/W 140 cm x P/D 33 cm. Rangements muraux/wall units PRATIK.

# QUADRA







Armoire de rangement LIFT. 2 miroirs coulissants verticalement dévoilent des étagères astucieuses avec prises de courant et casiers rangements pivotants. À poser sur pied, à suspendre ou à encastrer.

*LIFT storage unit. 2 vertically sliding mirrors conceal shelves and pivoting storage trays. Can be fitted on legs/plinth or built into a wall.*



Meuble PRATIK, un petit meuble 2 portes avec casiers pivotants, très fonctionnel. PRATIK cabinets is very functional being a small 2-door cabinet with swivelling trays.



# QUADRA



# QUADRA





Concept QUADRA51, façade/front F01, plan vasque/worktop SMO RAL5021, dimensions L/W 121 cm x P/D 50 cm.  
Miroir/mirror MIDO120. Colonnes/tall units QUADRAA3533G x 2. Receveur de douche assorti/matching shower tray ZBSR SMO RAL5021,  
dimensions L/W 90 cm x P/D 200 cm, panneaux de douche/wall cladding ZPAN SMO RAL5021, dimensions L/W 90 cm x H/H 220 cm.  
Composition sur-mesure assortie pour WC et bidet/made-to-measure WC and bidet units.



# KITOI

Concept KITO1400, façade/front M765, plan vasque/worktop Solid Surface, dimensions L/W 140 cm x P/D 50 cm, Miroir/mirror KITOMI140 + KITOMIPO, Banc avec coussin blanc/bench with white cushion KITOBAN + KITOBANTIR, Niches de rangement/storage shelves KITONI2H + KITONI3H + KITONI3V + KITONI x 2, Desserte sur roulettes avec coussin blanc/roller unit with white cushion KITOTAB.









Encadrement en Solid Surface blanc (vasque intégrée avec vidage invisible et cache amovible). Façade sans poignée, ouverture "push latch". Tiroir sous-vasque aménagé. Miroir en partie haute avec panneau décoratif assorti au meuble et éclairage périphérique par LEDs.  
*Moulded frame made from white Solid Surface (integrated basin with hidden and removable drain cover). "Push latch" drawers below the basin. Mirror with matching back panel and back-lit by LEDs.*





Concept KITO1001, façade/front M747, plan vasque/worktop Solid Surface, dimensions L/W 105 cm x P/D 50 cm. Miroir/mirror KITOMI105. Banc avec coussin blanc/bench with white cushion KITOBAN + KITOBANTIR. Niches de rangement/storage shelves KITONI2V. Desserte sur roulettes avec coussin blanc/roller unit with white cushion KITOTAB.



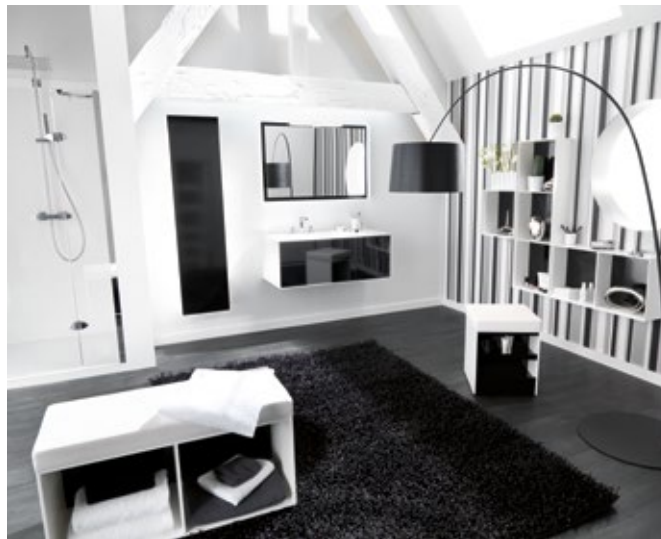

Concept KITO1001, façade/front 430, plan vasque/worktop Solid Surface, dimensions L/W 105 cm x P/D 50 cm. Miroir/mirror KITOMI105EC, option applique lumière/optional light fitting. Colonne/tall unit KITOAG + banc avec coussin blanc/bench with white cushion KITOBAN. Niches de rangement/storage shelves KITONI + KITONI3V + KITONI2H. Desserte sur roulettes avec coussin blanc/roller unit with white cushion KITOTAB.







Concept KITO1411, façade/front M735, encadrement et vasque/surround and basin Solid Surface, dimensions L/W 140 cm x P/D 50 cm. Miroir/mirror KITOMIPO + KITOMI140. Niches de rangement/storage shelves KITONI4V + KITONI2V + 2 x KITONI8015. Banc 2 tiroirs/bench with 2 drawers KITOBANTIR. Banc ouvert/open bench KITOBAN.

KITOI'









# EDEN



Concept EDEN120, meuble/unit L852, dimensions LW 120 cm x P/D 50 cm. Vasque/basin BOSVSQREC.  
Miroir/mirror EDENMI120. Colonnes/tall unit EDEN40D x 3.

# EDEN



Tiroir à ouverture par assistance électrique. Fond miroir et côtés en verre. Casier range-cosmétiques amovible. Eclairage LED à l'ouverture.

*Drawer with electrically-assisted opening. Mirrored bottom and glass runners. Removable dividers. LED lighting at the opening.*





Concept EDEN140, meuble/unit L842, dimensions L/W 140 cm x P/D 50 cm. Miroir/mirror EDENMI140.  
Vasque/basin BOSVQOVA. Colonnes/tall units EDEN40G x 2.



# TEMPO



Blocs tiroir/drawers unit TEMPBT70 x 3, L410.



Concept TEMPO, bloc tiroir/drawer unit TEMPBT70, façade/front L410, plateaux/worktops F47 et/and L410, dimensions L/W 280 cm x P/D 50 cm. Vasque/basin QUAD70. Mirrors/mirrors MILDH140.

# TEMPO



Ensemble de douche assorti à la vasque/matching shower: Receveur/shower tray ZBCAN SMO 274, dimensions L/W 90 cm x P/D 120 cm, panneaux de douche/wall cladding ZPAN SMO 274, dimensions L/W 90 cm x H/H 220 cm et/and L/W 120 cm x H/H 220 cm.







Concept TEMPO, bloc tiroir/drawer unit TEMPBAS140, façade/front L410, plateau/worktop L410, dimensions L/W 140 cm x P/D 50 cm.  
Vasque/basin QUAD70, SMO 274. Miroir/mirror MILDH140.



Concept TEMPO, façade/front L430, plateau/worktop L430, dimensions L/W 280 cm x P/D 50 cm. Miroir/mirror MINE140. Vasques/basins BOSVQOVA. Colonne/tall unit TEMPOA3533, dimensions L/W 35 cm x P/D 33 cm.

# TEMPO







Concept LIVAMI, plan vasque sur mesure/made-to-measure worktop Solid Surface, dimensions L/W 200 cm x P/D 54,5/44 cm. Demi-colonne/midi unit LILOFT. Niches de rangement/storage shelves collection KITOÏ, KITONI3V x 2 et/and KITONI8015 x 2.



Demi-colonne LILLOFT équipée de 2 tiroirs et de 2 prises de courant. Pratique, la poignée porte-serviettes et le range-flacons amovible.

*Midi unit LILLOFT with 2 drawers and 2 sockets. Practical, the handle holds a towel and drawer insert holds bottles.*



En cas de mobilité réduite, un fauteuil se glisse sous la vasque permettant un accès aisé au point d'eau. Le miroir légèrement penché vers l'avant assure une réflexion parfaite, même en position assise. Remontée arrière hygiénique.

*In cases of reduced mobility, a wheelchair can fit beneath the sink, allowing full access to the basin and tap. The mirror is slightly sloped downwards to give perfect reflection, even when seated. Hygienic raised upstand.*

# ABACA



Receveur de douche assorti/matching shower tray ZBSI SMO 268, dimensions L/W 120 cm x P/D 200 cm, panneaux de douche/wall cladding ZPAN SMO 268, dimensions L/W 120 cm x H/H 220 cm et/and L/W 200 cm x H/H 220 cm.





Concept ABACA, meuble/unit F47, plan vasque/worktop SMO 268, dimensions L/W 121 cm x P/D 45/60 cm. Miroir panoramique avec baldaquin, spots halogènes, prise de courant et interrupteur/panoramic mirror and light pelmet with integrated halogen lights.

# OMEGA

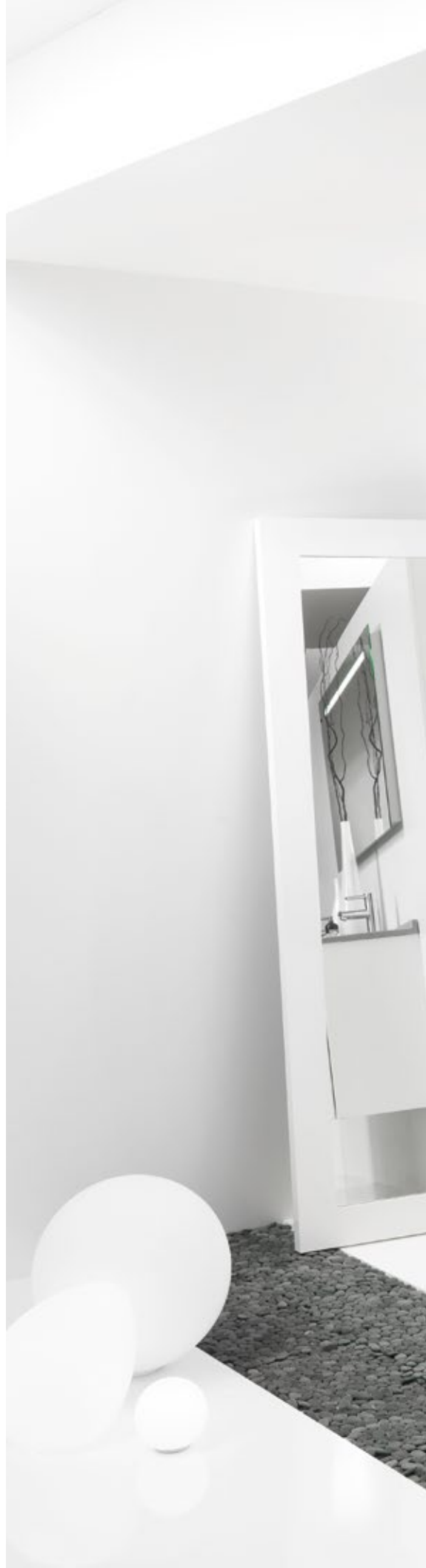





# ZETA



Concept ZETA71, meuble/unit 729, plan vasque/worktop SMO 267, dimensions L/W 140 cm x P/D 54/37 cm, Colonne assortie/matching tall unit ZETACORA33. Miroir panoramique avec baldaquin, spots halogènes, prise de courant et interrupteur/panoramic mirror and light pelmet with integrated halogen lights.









Concept YOKO921, meuble/unit 430, plan vasque/worktop SMO 200, dimensions L/W 95 cm x P/D 36/23 cm.  
Meuble pour WC suspendu assorti sur-mesure/made to measure wall hung WC unit.

# YOKO

Concept YOKO910, meuble/unit M410, plan vasque/worktop SMO RAL2008, dimensions L/W 60 cm x P/D 36/23 cm. Miroir/mirror MICA70 + ECCLD. Colonne pour WC suspendu assorti/matching wall hung WC unit COWC20.



# MAMBO



Concept MAMBO meuble/unit M410, plan vasque/  
worktop SMO 244, dimensions L/W 40 cm x P/D  
26 cm. Miroir/mirror MITB33 M410 + ECCHR.  
Meuble pour WC suspendu assorti/wall hung WC  
unit DCWC20, F27, tablette/shelf SMO 200 + fillers.



Concept MAMBO meuble/unit M747, plan vasque/  
worktop SMO 200, dimensions L/W 40 cm x P/D  
26 cm. Miroir/mirror MIBO + ECCHR.  
Meuble pour WC suspendu assorti/wall hung WC  
unit MBWC20 + fillers.



# DELTA



Concept DELTA110, façade/front 420, plan vasque/worktop SMO 222, dimensions L/W 125 cm x P/D 60/36 cm.  
Miroir/mirror MICLAS + ECLON.

# GUIDE TECHNIQUE

## TECHNICAL SPECIFICATIONS

Tous les meubles Ambiance Bain sont livrés montés et assemblés. Caissons en panneaux de particules PEFC 16 mm, assemblés par tourillons. Plans-vasques moulés d'une seule pièce en Béton de Synthèse antibactérien SMO™. Charnières et coulisses, réglables sur 3 axes, avec amortisseur intégré. Les tiroirs s'ouvrent intégralement pour un accès total au rangement et supportent une charge jusqu'à 50 kg (selon les modèles). Toutes les dimensions sont données en cm et à titre indicatif.

*All Ambiance Bain furniture units are delivered complete and assembled. Carcases made from PEFC 16 mm particleboard assembled with dowels. Worktop-basin, molded from a single piece of antibacterial SMO™ Synthetic Resin. Hinges and runners, adjustable in 3 planes, with built-in soft close feature. The drawers open completely to give total access to the storage space and can withstand a maximum load of 50 kg. All dimensions are given in cms and as a guide.*



FABRICATION  
FRANÇAISE



PLAN-VASQUE  
BÉTON SMO™



MEUBLE  
LIVRÉ MONTÉ



GARANTIE  
5 ANS\*



INSTALLATION  
FACILE



SOLUTIONS  
SUR-MESURE

WATERCONCEPT	85
ABACA	81
CAPIA	82
CITY	79
DELTA	83
DOLCE	80
EASYLIFE	78
EDEN	80
KITOÏ	78
MAMBO	83
MYSTA	82
OMEGA	81
PLAZZA	80
QUADRA	79
TAKOMA	81
TEMPO	78
YOKO	83
ZETA	83

\* Voir conditions générales de vente / Please refer to our terms and conditions

## KITOÏ Collection page 46

Plan-vasque et encadrement en Solid Surface blanc.  
Ouverture des tiroirs sans poignée par "push latch".

Worktop-basin and surround made from white Solid Surface.  
Drawers open without handles using the "push latch" system.

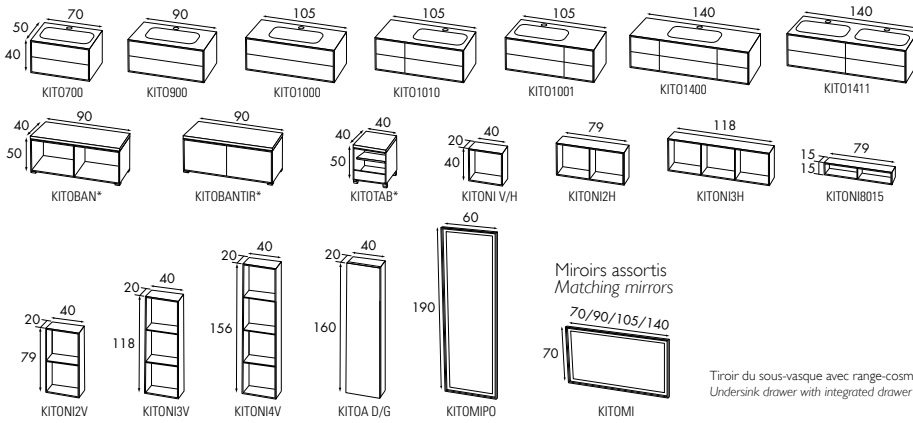

Concept KITO700, façade/front M713.  
Miroir assorti/matching mirror KITOMI70. Colonne/tall unit KITOAD.

- \* Coussins blancs fournis
- \* White cushions supplied

### [ KITOÏ ] FAÇADE / FRONT



\* Coloris Brillant / Gloss Colour

## EASYLIFE Collection page 64

Le plan vasque suspendu est en Solid Surface Blanc.  
Le grand miroir légèrement incliné repose sur la remon-  
tée arrière qui évite les projections d'eau et facilite  
l'entretien quotidien.

The wall panel with suspended basin is made from white  
Solid Surface. The large, slightly-sloped mirror rests on the  
raised upstand, which prevents water splashing and makes  
cleaning easier.

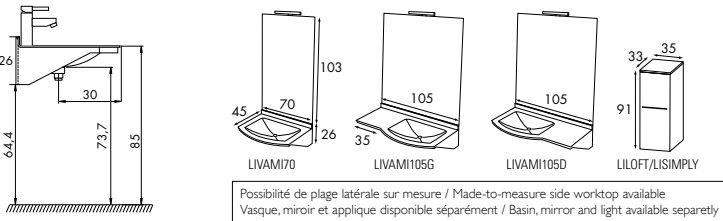

- LOFT
- 1 tablette fixe
  - 1 tablette réglable
  - 2 tiroirs coulissants
  - 1 range-flacons amovible dans le tiroir en partie basse
  - 2 prises de courant
- SIMPLY
- 2 tablettes réglables

Possibilité de plage latérale sur mesure / Made-to-measure side worktop available  
Vasque, miroir et applique disponible séparément / Basin, mirror and light available separately

### [ EASYLIFE ] MEUBLE / UNIT



\* Coloris Brillant / Gloss Colour



Concept LIVAM1105D avec plage sur-mesure

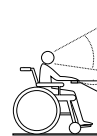

En cas de mobilité réduite, un fauteuil se glisse sous la vasque permettant un accès aisé au point d'eau. Le miroir légèrement penché vers l'avant assure une réflexion parfaite, même en position assise.  
In cases of reduced mobility a wheelchair slides beneath the sink allowing full access to the basin and tap. The mirror is slightly sloped downwards to give a perfect reflection, even when seated.

## TEMPO Collection page 58

Composez un ensemble entièrement personnalisé grâce aux multiples possibilités d'associations du mobilier Tempo.

Make up a completely personalised bathroom using the multiple colour-coordinating possibilities of the Tempo furniture.

PLAN DE TOILETTE / WORKTOP

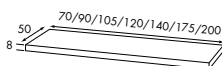

Egalement sur-mesure / Made-to-measure available

FIXÉ SOUS LE PLAN DE TOILETTE / UNDERNEATH WORKTOP

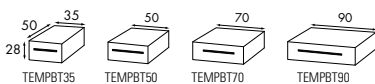

INDEPENDANT DU PLAN DE TOILETTE / INDEPENDENT

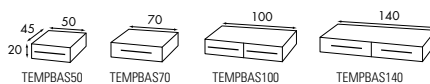

### [ TEMPO ] MEUBLE ET PLAN DE TOILETTE / UNIT & WORKTOP

\* Coloris Brillant / Gloss Colour

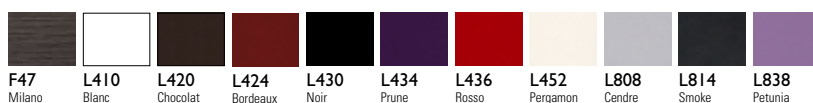

Différentes vasques à poser SMO™ ou Solid Surface, voir page 85.  
Different SMO™ or Solid Surface basins to be installed, see page 85.



## ■ QUADRA (SMO™) Collection page 40

Grand couissant accompagné d'un tiroir à "l'anglaise" équipé d'un range-cosmétiques astucieux. La grande vasque rectangulaire est d'une épaisseur de 10 cm.

Large sliding drawer combined with a hidden drawer fitted with a clever cosmetics storage tray. The large rectangular basin is 10 cm thick.

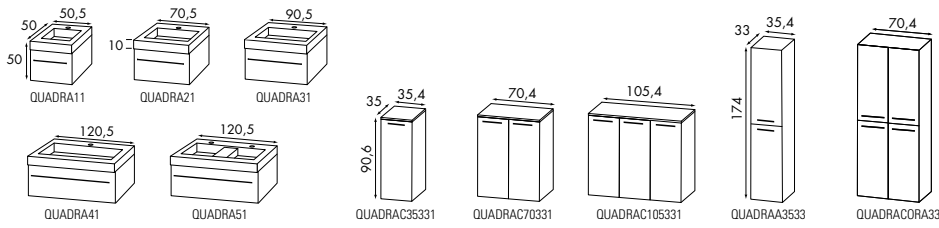

Tiroir du sous-vasque avec range-cosmétiques intégrés / Undersink drawer with integrated drawer inserts



Concept QUADRA31, meuble/unit 434, plan vasque/worktop SMO 213.

## ■ CITY (SMO™) Collection page 24

Un modèle de référence disponible dans de nombreuses dimensions, avec ou sans bloc tiroir latéral, aligné ou en décroché. Vasque profonde, grand volume de rangement et petite remontée arrière pour une plus grande facilité d'entretien. 3 types d'ouvertures aux choix.

A versatile model available in many sizes, with or without side drawer unit, aligned or offset. Deep basin, large storage volume and small raised upstand for easy cleaning. 3 different kinds of front.

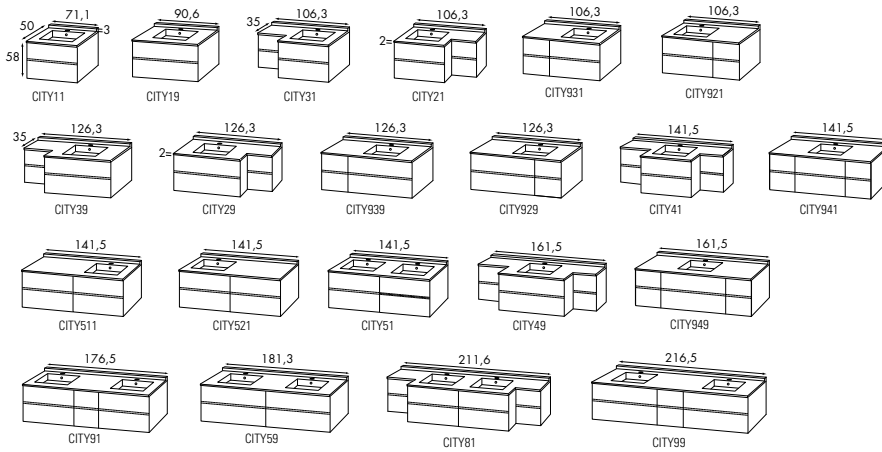

Tiroir du sous-vasque avec range-cosmétiques intégré / Undersink drawer with integrated drawer inserts



Prise de main (PM)



Sans poignée, ouverture push-latch (PU)



5 poignées au choix (PO)

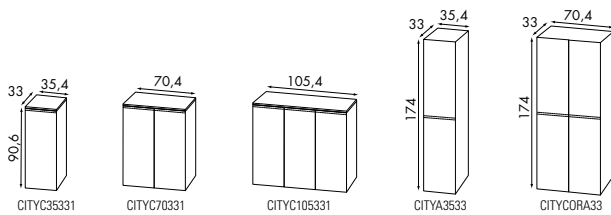

5 poignées au choix / Choice of 5 different handles



\* Poignée par défaut si non précisé

### [ QUADRA - CITY ] MEUBLE / UNIT



\* Coloris Brillant / Gloss Colour

### VASQUES, RECEVEURS ET PANNEAUX DE DOUCHE SMO™ / SYNTHETIC RESIN SMO™ WORKTOPS, SHOWER TRAYS AND WALL CLADDINGS



\* Coloris Brillant / Gloss Colour

## ■ DOLCE (SMO™) Collection page 18

Dolce avec ses côtés galbés, son profilé chromé et sa prise de main, dispose également d'un très grand volume de rangement. Miroir assorti.

*Dolce, with its rounded edges, chromed trim and handgrip, also has a very large storage volume. Matching mirror.*

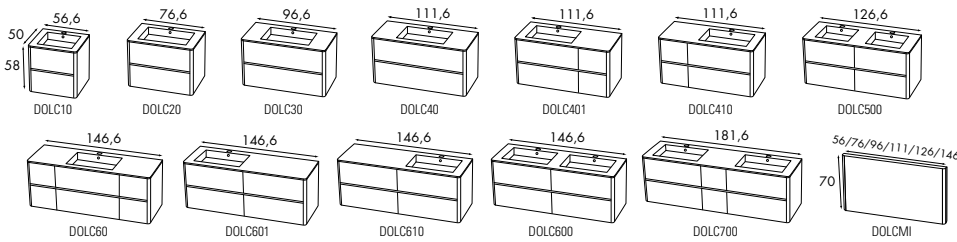

Tiroir du sous-vasque avec range-cosmétiques intégré / Undersink drawer with integrated drawer inserts



Concept DOLCE60, meuble/unit F01, plan vasque/worktop SMO 214.

### [ DOLCE ] MEUBLE / UNIT

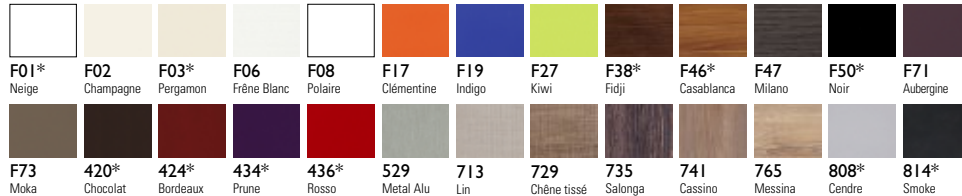

\* Coloris Brillant / Gloss Colour

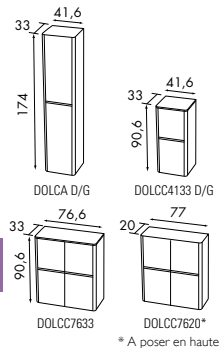

\* A poser en hauteur

## ■ EDEN Collection page 54

Ligne sobre et chic pour ce modèle laqué surplombé d'une vasque déco en Solid Surface\*. Tiroir à ouverture par assistance électrique. Miroir assorti.

*Simple but stylish design for this lacquered model topped with a designer basin made from Solid Surface\*. Drawer with electrically-assisted opening. Matching mirror.*

\* Voir page 85 / See page 85

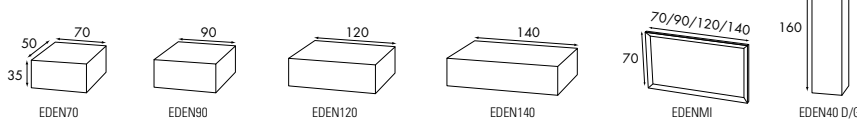

Tiroir avec range-cosmétiques intégré / Drawer with integrated drawer inserts



Concept EDEN120, meuble/unit L430, vasque/basin BOSVQREC\*.

## ■ PLAZZA (SMO™) Collection page 12

Façade en relief laquée (Q), lisse (L) ou personnalisée (P) pour cette ligne contemporaine sans poignée. Tiroir à ouverture manuelle (M) ou par assistance électrique (E) en option. Vasque semi encastrée SMO™ (épaisseur 3 cm). Miroir assorti.

*Patterned lacquered (Q), smooth (L) or personalized (P) front for this modern handleless line. Manually opening (M) or electrically assisted (E) drawer (optional). The semi-recessed basin is made from antibacterial SMO™ Synthetic Resin. Matching Mirror.*

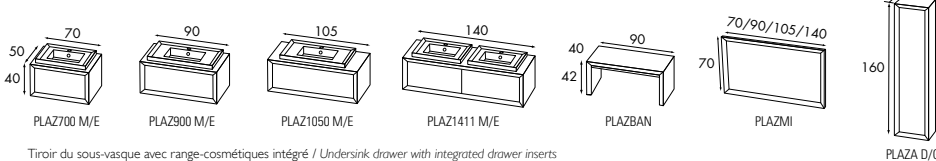

Tiroir du sous-vasque avec range-cosmétiques intégré / Undersink drawer with integrated drawer inserts



Concept PLAZ1050ML, meuble/unit L850, plan vasque/worktop SMO 267.

### [ EDEN - PLAZZA ] MEUBLE / UNIT

Brillant / Gloss



Métallisé / Pearl

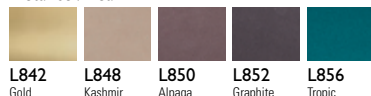

### [ PLAZZA ]

3 types de façades disponibles :

- Lisse (L)
- Quadrillage relief (Q)
- Personnalisé (P) : selon votre motif

3 types of front are available :

- Smooth (L)
- Embossed grid (Q)
- Personalized (P) : to your own pattern

### VASQUES, RECEVEURS ET PANNEAUX DE DOUCHE SMO™

\* Coloris Brillant

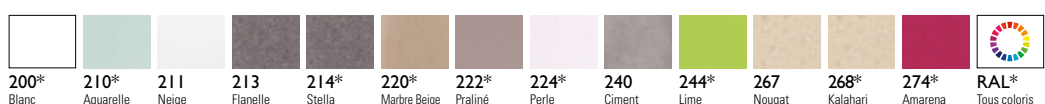

## TAKOMA (SMO™) Collection page 36

Meuble galbé, Takoma possède une grande vasque avec remontée arrière et de larges tiroirs coulissants. Les compositions disponibles offrent de nombreuses solutions d'agencement. Deux poignées au choix.

With a curved front, the Takoma unit has a large basin with raised upstand and large sliding drawers. The available compositions offer several layout possibilities. Selection of 2 handles.

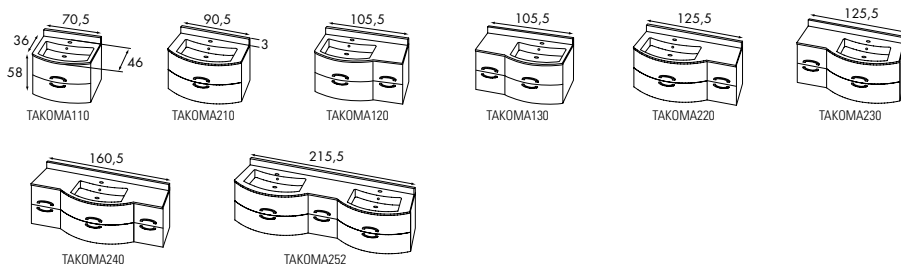

Tiroir du sous-vasque avec range-cosmétiques intégré / Undersink drawer with integrated drawer inserts

Poignées au choix / Choice of 2 different handles



\* Poignée par défaut si non précisé



Poignée demi-lune (38)



Poignée galbée (73)

## OMEGA (SMO™) Collection page 68

Ce meuble double vasque, aux courbes et proportions généreuses, possède une des plus grande capacité de rangement de la collection.

This double-basin unit, with generous curves and proportions, has one of the largest storage capacities in the collection.



Concept OMEGA, meuble/unit F01, plan vasque/worktop SMO 214.

## ABACA (SMO™) Collection page 66

Plus petit qu'Omega, Abaca, avec une seule vasque centrale, est équipé de 6 tiroirs.

Smaller than Omega, Abaca, with a single central basin, is fitted with 6 drawers.



Concept ABACA, meuble/unit F47, plan vasque/worktop SMO 268.

### [ TAKOMA - OMEGA - ABACA ] MEUBLE / UNIT

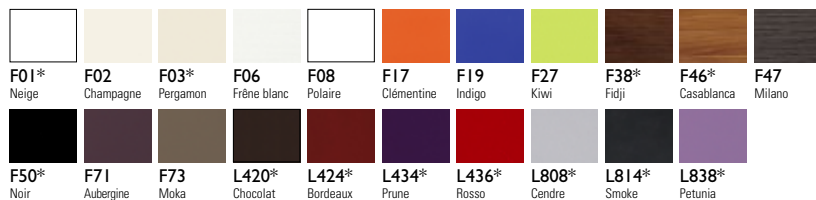

\* Coloris Brillant / Gloss Colour



SYNTHETIC RESIN SMO™  
WORKTOPS, SHOWER TRAYS  
AND WALL CLADDINGS

\* Gloss Colour



## ■ CAPIA (SMO™) Collection page 30

Capia propose un grand volume de rangement et une multitude de solutions de compositions tiroirs ou portes. Large poignée chromée.

Capia proposes large storage space and plenty of composition possibilities with doors and drawers. Large chromed handles.

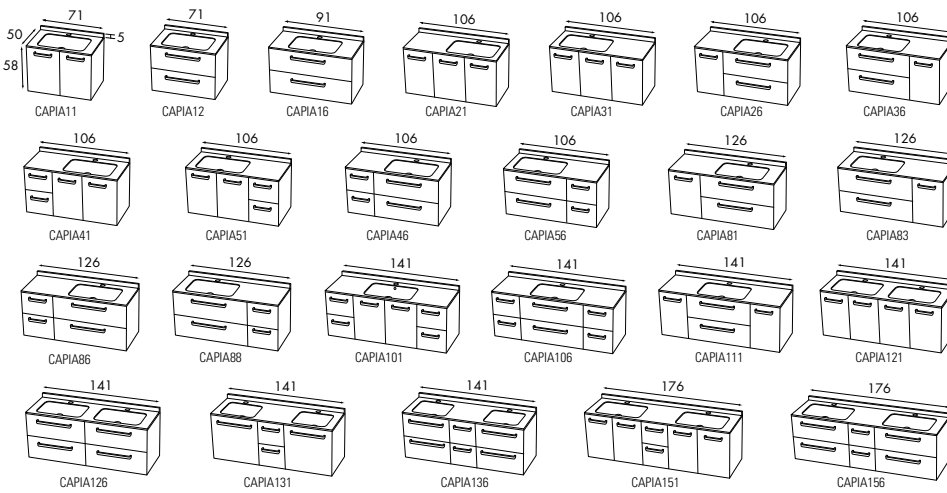

Concept CAPIA156, meuble/unit F01, plan vasque/worktop SMO 214.

### [ CAPIA ] MEUBLE / UNIT

Tiroir du sous-vasque avec range-cosmétiques intégré / Undersink drawer with integrated drawer inserts



\* Coloris Brillant / Gloss Colour

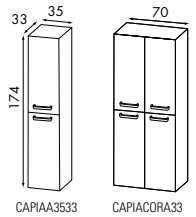
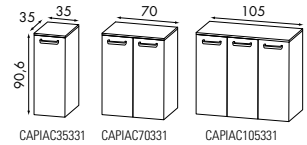

## ■ MYSTA (SMO™) Collection page 34

Mysta est un concept aux portes moulurées chics et subtiles. Le bouton aspect glaçon souligne ce modèle d'élégance. Plan-vasque avec petite-remontée arrière.

Mysta is a concept with elegant and subtled structured fronts. An ice-cube styled button highlight this stylish design. Worktop with rear upstand.

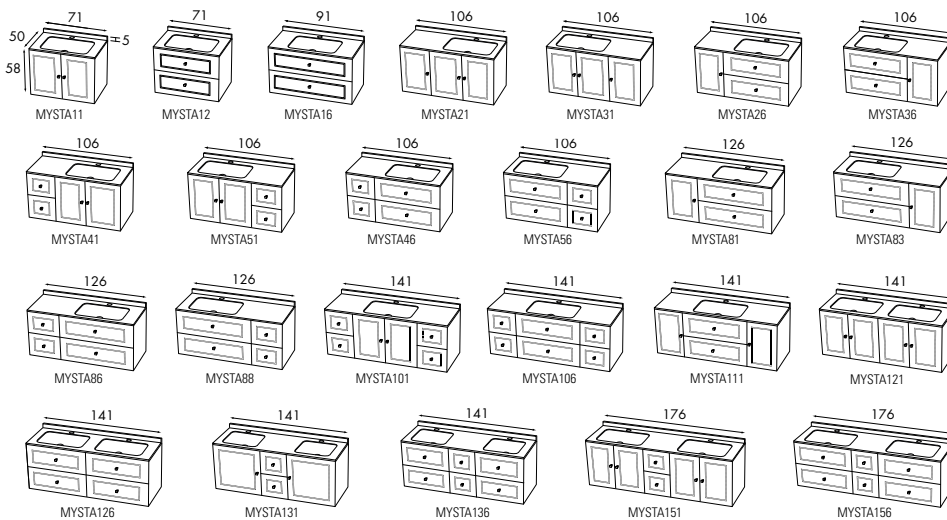

Concept MYSTA101, meuble/unit F01, plan vasque/worktop SMO 214. Armoire de toilette/Mirror cabinet ATNE.

### [ MYSTA ] MEUBLE / UNIT

Tiroir du sous-vasque avec range-cosmétiques intégré / Undersink drawer with integrated drawer inserts



\* Coloris Brillant / Gloss Colour

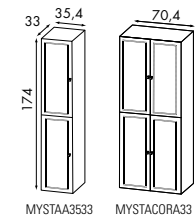
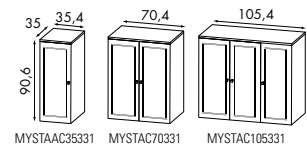

### VASQUES, RECEVEURS ET PANNEAUX DE DOUCHE SMO™

\* Coloris Brillant

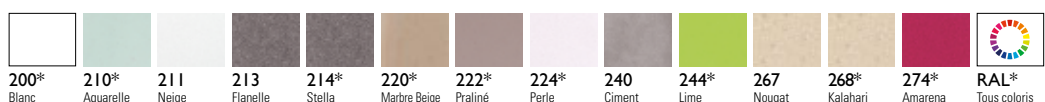

## ZETA (SMO™) Collection page 70

Ce meuble galbé pour les grandes comme pour les petites salles de bains offre une grande vasque aux lignes arrondies.

*This rounded unit for large and small bathrooms has a large basin with rounded style.*

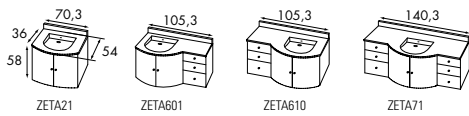

Concept ZETA71, meuble/unit 713, plan vasque/worktop SMO 200.

## DELTA (SMO™) Collection page 76

Le plan de toilette Delta plonge progressivement dans la vasque. Des courbes douces pour l'esthétique et l'hygiène.

*The Delta worktop descends gradually into the basin. Gentle curves for aesthetics and hygiene.*

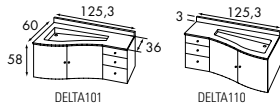

Concept DELTA110, meuble/unit 420, plan vasque/worktop SMO 222.

### [ DELTA - ZETA ] MEUBLE / UNIT

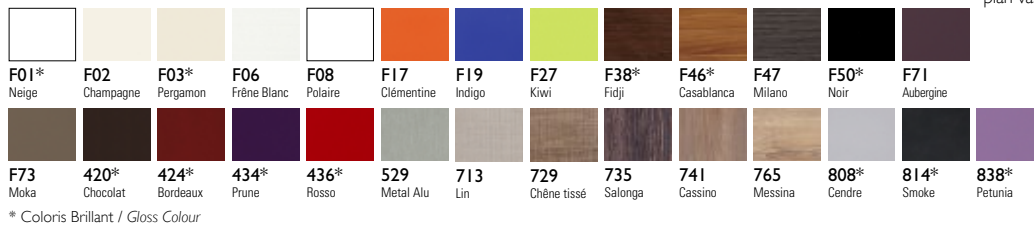

## YOKO (SMO™) Collection page 72

La forme de Yoko permet, dans les petites salles de bains, de dégager le passage d'une porte.

*Yoko can be fitted in asymmetrical bathrooms, freeing-up room to move in bathrooms where the door does not leave much space.*

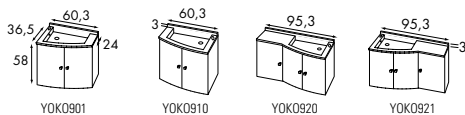

Concept YOKO, meuble/unit M729, plan vasque/worktop SMO 200.

### [ YOKO ] MEUBLE / UNIT

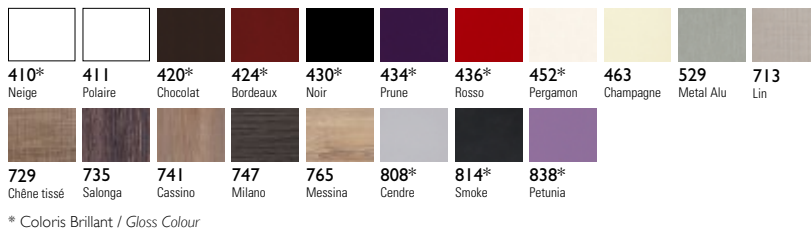

## MAMBO (SMO™) Collection page 75

Ce lave-mains de faible dimension offre une vasque profonde avec remontée arrière et une poignée porte-serviettes. Ouverture droite ou gauche.

*This small basin unit has a deep basin with raised upstand and towel rail handle. Opening right or left.*

### [ MAMBO ] MEUBLE / UNIT

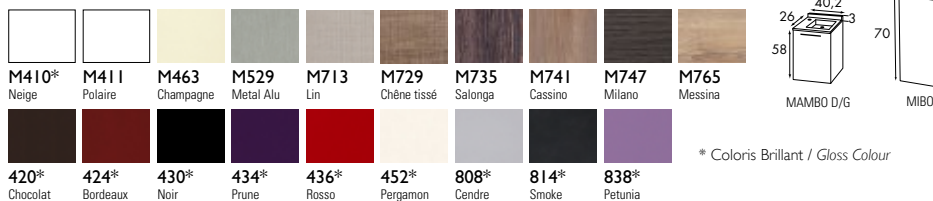

Concept MAMBO, meuble/unit M410, plan vasque/worktop SMO 244.



SYNTHETIC RESIN SMO™  
WORKTOPS, SHOWER TRAYS  
AND WALL CLADDINGS

\* Gloss Colour

## SOLUTIONS DE RANGEMENTS / STORAGE SOLUTIONS

Ambiance Bain propose une multitude de rangements complémentaires, renseignez-vous auprès de votre revendeur. Coloris, poignées et finitions assortis au meuble vasque de votre choix.

Ambiance Bain offers a large number of additional storage units, contact your retailer for details. Colours, handles and finishes to match your chosen basin unit.

### RANGEMENTS MURAUX WALL UNITS

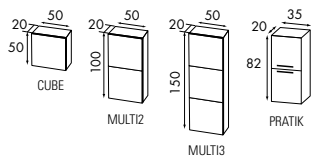

### COLONNES ET DEMI-COLONNES MID COLUMN AND TALL UNITS

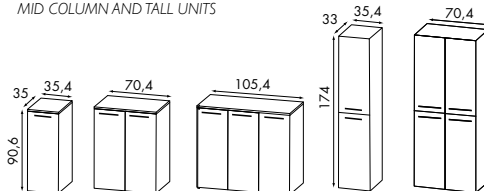

### MEUBLES POUR WC OU BIDET SUSPENDU WALL HUNG WC AND BIDET UNITS

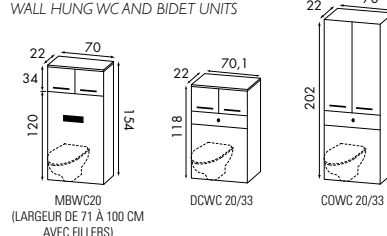

Possibilité de tablette SMO™ assortie au plan-vasque.  
Possibility of SMO™ shelf matching the basin unit.

## LIFT Page 40

Armoire de rangement à poser sur pieds, à suspendre ou à encastrer. 2 miroirs coulissants verticalement dévoilent des étagères astucieuses. Eclairage des tablettes par LED.

Storage cabinet to be installed on feet, on the wall or recessed. 2 vertically-sliding mirrors reveal clever shelves. LED shelf lighting.

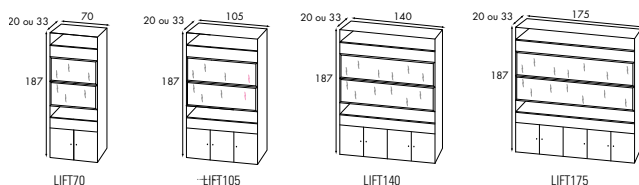

Concept LIFT70 façade/front F01 intérieur/inside M529.

### FAÇADE / FRONT



### CAISSON ET NICHES / CARCASE

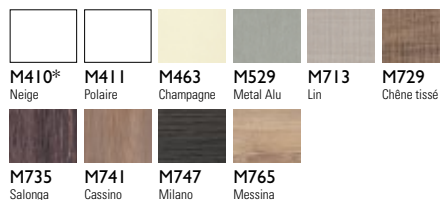

\* Coloris Brillant / Gloss Colour

## MIROIRS & ARMOIRES DE TOILETTE / MIRRORS & CABINETS

Miroir avec tableau assorti au meuble  
Mirror with back panel matching the unit

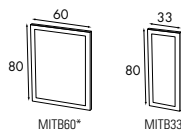

Miroir tactile avec éclairage LED  
Tactile mirror with LED lighting

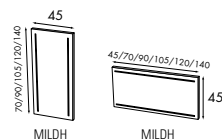

Miroir avec appliques LED latérales  
Mirror with lateral LED lighting brackets

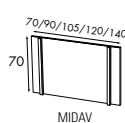

Armoire de toilette  
Mirror cabinets

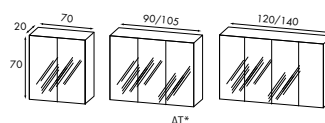

Miroir avec éclairage fluorescent  
Mirror with fluorescent lighting

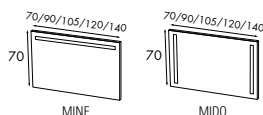

Miroir sur cadre aluminium  
Mirror on aluminum frame

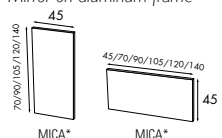

Grand miroir sur montants arrière  
Large mirror on frame

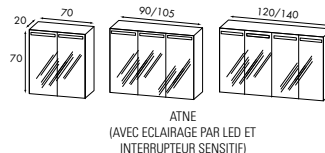
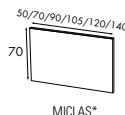

\* Sans éclairage / Without lights

Grand miroir panoramique  
Large panoramic mirror

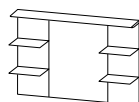

De nombreuses dimensions, renseignez-vous auprès de votre revendeur.  
Too numerous to list. Contact your retailer to explore the available options.

### APPLIQUES / LIGHTS

Pour les miroirs non équipés d'éclairage, choisissez entre nos différentes appliques complémentaires.  
For mirrors not fitted with lighting, choose from our different additional light fittings.

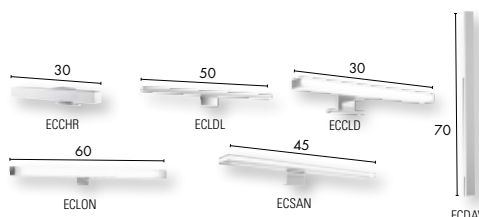



## ■ WATERCONCEPT (SMO™)

### RECEVEURS SUR-MESURE / MADE-TO-MEASURE SHOWER TRAY

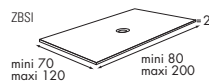

Receveur à encastrer  
Shower tray to be recessed

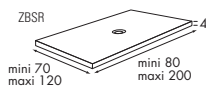

Receveur à poser  
Surface-mounted shower tray

### RECEVEURS STANDARDS / STANDARDS SHOWER TRAY

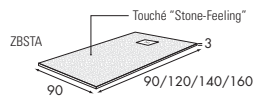

Receveur standard touché "Stone Feeling"  
Standard "Stone Feeling" shower tray

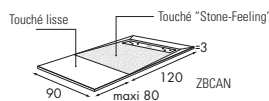

Receveur à écoulement type "caniveau"  
"Channel Waste" shower tray

### PANNEAUX ET BANCS DE DOUCHE / WALL CLADDING AND SHOWER BENCH

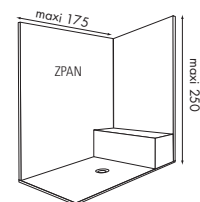

Panneaux de douche  
Wall cladding

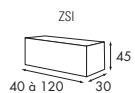

Banc de douche  
Shower bench

**WATERCONCEPT** : Grâce au SMO™, vous pouvez accorder votre douche (receveur et panneaux) avec votre plan vasque. Découvrez tous les avantages du Béton de Synthèse Antibactérien SMO™ de la page 4 à la page 11.

**WATERCONCEPT** : Thanks to SMO™, you can match your shower (shower tray and wall cladding) with your basin unit. Discover all the advantages of Antibacterial SMO™ Synthetic Resin from page 4 to 11.

### PLAN-VASQUES, RECEVEURS ET PANNEAUX DE DOUCHE SMO™

#### SYNTHETIC RESIN SMO™ WORKTOPS, SHOWER TRAYS AND WALL CLADDINGS

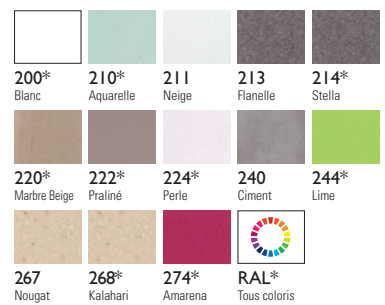

\* Coloris Brillant / Gloss Colour

## ■ VASQUES / BASINS

### VASQUES EN BÉTON DE SYNTHÈSE SMO™ ANTIBACTÉRIEN SMO™ SYNTHETIC RESIN BASINS

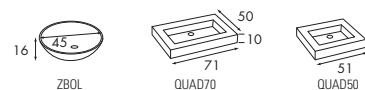

### VASQUES EN SOLID SURFACE BLANC WHITE SOLID SURFACE BASINS



Disponibles dans les coloris de la gamme de Béton de Synthèse SMO™ et dans toutes les teintes RAL. Available in the colours of SMO™ Synthetic Resin and RAL colours.

Conception et réalisation Korigan (www.korigan.fr), photos Yann Geoffray et Guy Renaux, Grupo Grafico et autres...

Photos et nuances de coloris non contractuelles. Sous réserve d'erreurs typographiques. Dans un but d'amélioration, Ambiance Bain se réserve le droit de modifier ou supprimer à tout moment les caractéristiques de ses produits. Toutes les dimensions sont données en cm et à titre indicatif. Les marques Ambiance Bain et SMO™ sont des marques exclusives du groupe Akalys. Toute reproduction, même partielle, de ce document est strictement interdite. Ambiance Bain janvier 2014.  
Photos and colour charts are non-contractual. Subject to typographical errors. With the aim of improvement, Ambiance Bain reserves the right to change or delete the characteristics of its products at any time. All dimensions are given in cms and as a guide. The Ambiance Bain and SMO™ brands are exclusive trademarks of the Akalys group. All copy, even partial, of this document is strictly prohibited. Ambiance Bain January 2014.



AMBIANCE BAIN  
BP 206 - 07502 GUILHERAND GRANGES CEDEX  
FRANCE

**FRANCE**

TÉL : +33 (0)4 75 44 32 70 / +33 (0)4 75 44 94 06 - FAX : +33 (0)4 75 42 39 92  
info@ambiancebain.com

**EXPORT**

Tel : +33 (0)4 26 60 91 01 - Fax : +33 (0)4 75 42 39 92  
export@ambiancebain.com

[www.ambiancebain.com](http://www.ambiancebain.com)